

Voltage monitoring relay CM-EFS.2

For single-phase AC/DC voltages

The CM-EFS.2 is an electronic voltage monitoring relay that provides reliable monitoring of voltages as well as detection of phase loss.

All devices are available with two different terminal versions. You can choose between the proven screw connection technology (double-chamber cage connection terminals) and the completely tool-free Easy Connect Technology (Push-in terminals).

Characteristics

- Monitoring of DC and AC voltages (3-600 V)
- TRMS measuring principle
- One device includes 4 measuring ranges
- Over- and undervoltage monitoring
- ON- or OFF-delay configurable
- Latching function configurable
- Threshold values for >U and <U adjustable
- Fixed hysteresis (5 %)
- Precise adjustment by front-face operating controls
- Screw connection technology or Easy Connect Technology available
- Housing material for highest fire protection classification UL 94 V-0
- Tool-free mounting on DIN rail as well as demounting
- Tripping delay T_V adjustable (0 s; 0.1-30 s)
- 1x2 c/o (SPDT) contacts (common signal) or 2x1 c/o (SPDT) contact (separate signals for >U and <U) configurable
- 22.5 mm (0.89 in) width
- 3 LEDs for status indication

Order data

Voltage monitoring relay

Type	Rated control supply voltage	Connection technology	Measuring ranges	Order code
CM-EFS.2P	24-240 V AC/DC	Push-in terminals	3-30 V, 6-60 V, 30-300 V, 60-600 V	1SVR 740 750 R0400
CM-EFS.2S	24-240 V AC/DC	Screw type terminals	3-30 V, 6-60 V, 30-300 V, 60-600 V	1SVR 730 750 R0400

Accessories

Type	Description	Order code
ADP.01	Adapter for screw mounting	1SVR 430 029 R0100
MAR.12	Marker label for devices with DIP switches	1SVR 730 006 R0000
COV.11	Sealable transparent cover	1SVR 730 005 R0100

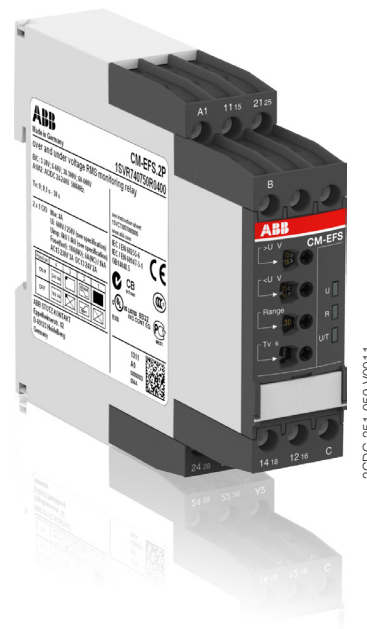

20DC 251 059 V0011

Approvals

- UL[®] UL 508, CAN/CSA C22.2 No.14
- GL (pending)
- GOST
- CB Scheme
- CCC
- RMRS

Marks

- CE CE
- C-Tick C-Tick

Connection technology

Maintenance free Easy Connect Technology with Push-in terminals

Type designation CM-xxS.yyP

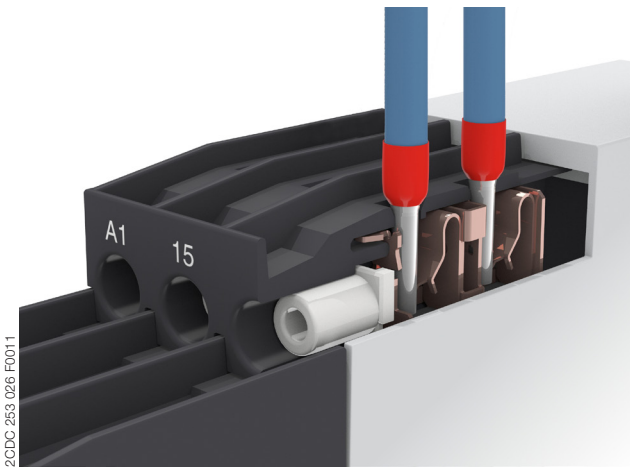

Push-in terminals

- Tool-free connection of rigid and flexible wires with wire end ferrule according to DIN 46228-1-A, DIN 46228-4-E
Wire size: 2 x 0.5-1.5 mm², (2 x 20 - 16 AWG)
- Easy connection of flexible wires without wire end ferrule by opening the terminals
- No retightening necessary
- One operation lever for opening both connection terminals
- For triggering the lever and disconnecting of wires you can use the same tool (Screwdriver according to DIN ISO 2380-1 Form A 0.8 x 4 mm (0.0315 x 0.157 in), DIN ISO 8764-1 PZ1 ø 4.5 mm (0.177 in))
- Constant spring force on terminal point independent of the applied wire type, wire size or ambient conditions (e. g. vibrations or temperature changes)
- Opening for testing the electrical contacting
- Gas-tight

Approved screw connection technology with double-chamber cage connection terminals

Type designation CM-xxS.yyS

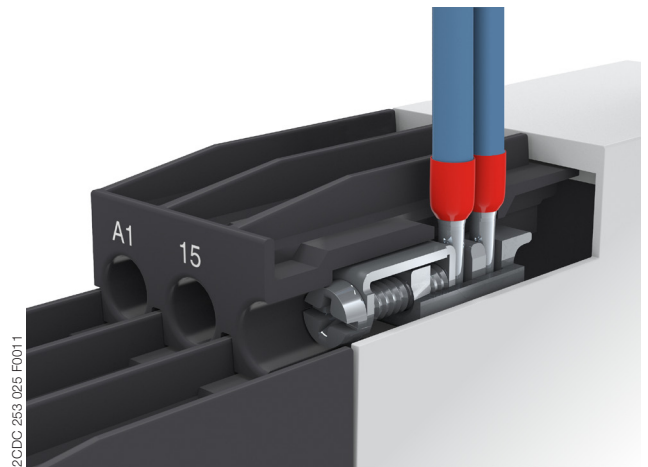

Double-chamber cage connection terminals

- Terminal spaces for different wire sizes:
fine-strand with/without wire end ferrule:
1 x 0.5-2.5 mm² (2 x 20 - 14 AWG),
2 x 0.5-1.5 mm² (2 x 20 - 16 AWG)
rigid:
1 x 0.5-4 mm² (1 x 20 - 12 AWG),
2 x 0.5-2.5 mm² (2 x 20 - 14 AWG)
- One screw for opening and closing of both cages
- Pozidrive screws for pan- or crosshead screwdrivers according to DIN ISO 2380-1 Form A 0.8 x 4 mm (0.0315 x 0.157 in), DIN ISO 8764-1 PZ1 ø 4.5 mm (0.177 in)

Both the Easy Connect Technology with Push-in terminals and screw connection technology with double-chamber cage connection terminals have the same connection geometry as well as terminal position.

Functions

Operating controls

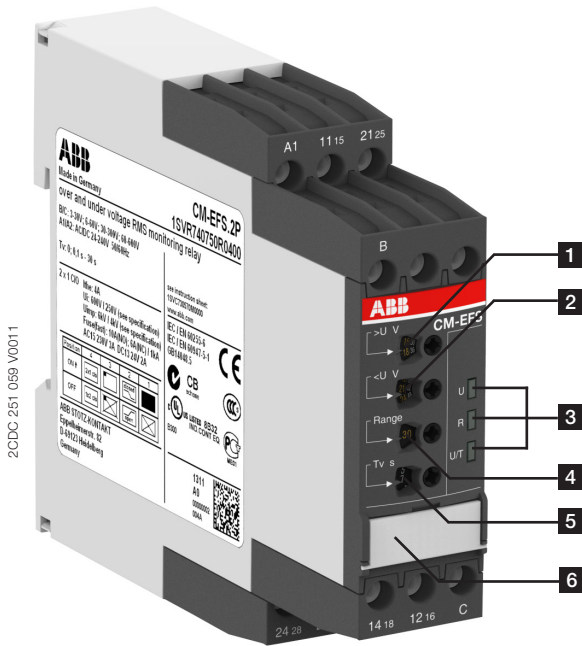

1 Adjustment of the threshold value >U for overvoltage

2 Adjustment of the threshold value <U for undervoltage

3 Indication of operational states

U/T: green LED – control supply voltage/timing

R: yellow LED – relay status

U: red LED – over- / undervoltage

4 Adjustment of the measuring range

5 Adjustment of the tripping delay T_v

6 DIP switches (see DIP switch functions)











When compared with our previous version, the position of the adjustment potentiometers 4 and 5 have changed places.

Application

The voltage monitoring relays CM-EFS.2 are designed for use in single-phase AC and/or DC systems for the simultaneous monitoring of over- or undervoltages as well as detection of phase loss. Depending on the configuration, one c/o (SPDT) contact each or both c/o (SPDT) contacts in parallel can be used for the over- and undervoltage monitoring. The devices operate over an universal range of supply voltages and provide an adjustable tripping delay. Open or closed-circuit principle as well as ON or OFF delay tripping are configurable.

Operating mode

The CM-EFS.2 have 2 c/o (SPDT) contacts and include 4 measuring ranges: 3-30 V, 6-60 V, 30-300 V and 60-600 V.

The units are adjusted with front-face operating controls. The selection of: ON-delay  or OFF-delay , open-  or closed-circuit principle , latching function ON  or OFF  and 2x1 c/o  or 1x2 c/o (SPDT) contacts  is made with DIP switches. Potentiometers, with direct reading scale, allow the adjustment of the threshold value_{max} (>U) for overvoltage, the threshold value_{min} (<U) for undervoltage and the tripping delay T_v. The tripping delay T_v is adjustable over a range of instantaneous to a 30 s delay. The hysteresis is fixed at 5 %. Timing is displayed by a flashing green LED labelled U/T.

Function diagrams

Voltage window monitoring 1x2 c/o (SPDT) contacts  ON-delayed  without latching 

Open-circuit principle 

The voltage to be monitored (measured value) is applied to terminals B-C. The control supply voltage applied to terminals A1-A2 is displayed by the glowing green LED.

If the measured value exceeds the threshold value e_{max} ($>U$) or drops below the threshold value e_{min} ($<U$), the tripping delay T_V starts and the red LED glows (overvoltage), or flashes  (undervoltage) respectively.

Timing of T_V is displayed by the flashing  green LED.

When T_V is complete and the measured value still exceeds the threshold value e_{max} minus the fixed hysteresis (5 %) or is still below the threshold value e_{min} plus the fixed hysteresis (5 %), the output relays energize and the yellow LED (relay energized) glows.

If the measured value decreases below the threshold value e_{max} minus the fixed hysteresis (5 %) or exceeds the threshold value e_{min} plus the fixed hysteresis (5 %), the output relays de-energize and the red and yellow LEDs turn off.

If control supply voltage is interrupted, the green LED turns off.

Closed-circuit principle 

The voltage to be monitored (measured value) is applied to terminals B-C. When control supply voltage is applied to terminals A1-A2, the output relays energize and the green and yellow LED (relays energized) glow.

If the measured value exceeds the threshold value e_{max} ($>U$) or drops below the threshold value e_{min} ($<U$), the tripping delay T_V starts and the red LED glows (overvoltage), or flashes  (undervoltage) respectively.

Timing of T_V is displayed by the flashing  green LED.

When T_V is complete and the measured value still exceeds the threshold value e_{max} minus the fixed hysteresis (5 %) or is still below the threshold value e_{min} plus the fixed hysteresis (5 %), the output relays de-energize and the yellow LED (relays energized) turns off.

If the measured value decreases below the threshold value e_{max} minus the fixed hysteresis (5 %) or exceeds the threshold value e_{min} plus the fixed hysteresis (5 %), the output relays re-energize, the yellow LED glows and the red LED turns off.

If control supply voltage is interrupted, the output relays de-energize and the yellow and green LEDs turn off.

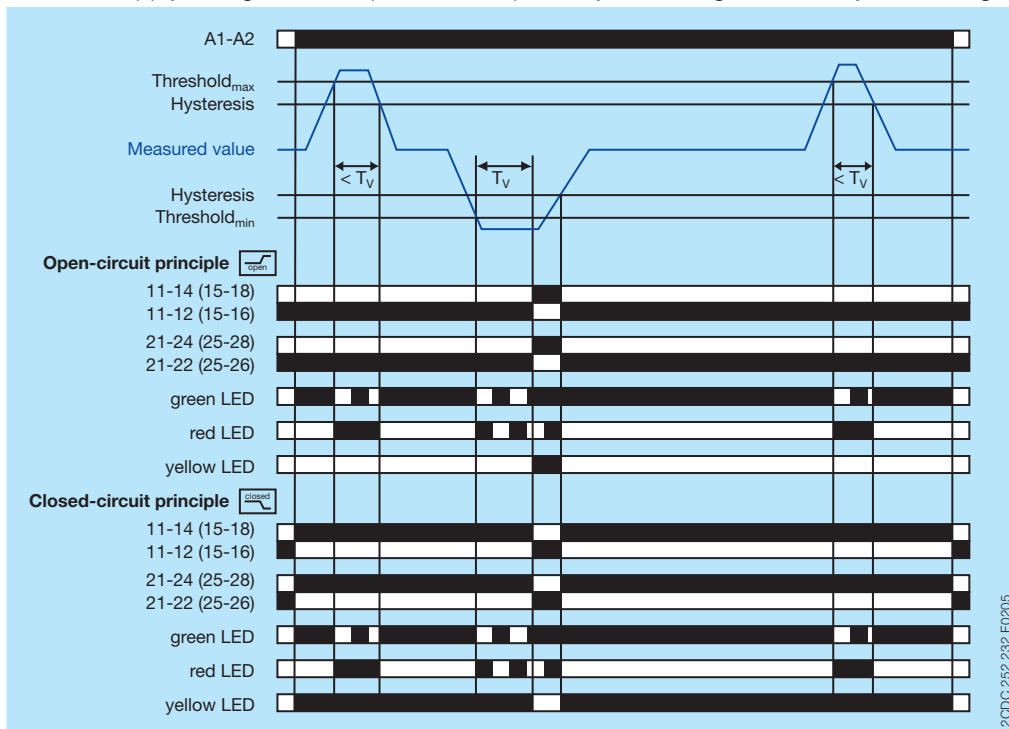

2CDC 252 232 F0205

Voltage window monitoring 1x2 c/o (SPDT) contacts  OFF-delayed  without latching 

Open-circuit principle 

The voltage to be monitored (measured value) is applied to terminals B-C. The control supply voltage applied to terminals A1-A2 is displayed by the glowing green LED.

If the measured value exceeds the threshold value_{max} (>U) or drops below the threshold value_{min} (<U), the output relays energize, the yellow LED (relays energized) glows and the red LED glows (overvoltage), or flashes  (undervoltage) respectively.

If the measured value decreases below the threshold value_{max} minus the fixed hysteresis (5 %) or exceeds the threshold value_{min} plus the fixed hysteresis (5 %), the tripping delay T_V starts and the red LED turns off.

Timing of T_V is displayed by the flashing  green LED. When T_V is complete, the output relays de-energize and the yellow LED (relay energized) turns off.

If control supply voltage is interrupted, the green LED turns off.

Closed-circuit principle 

The voltage to be monitored (measured value) is applied to terminals B-C. When control supply voltage is applied to terminals A1-A2, the output relays energize and the green and yellow LED (relays energized) glow.

If the measured value exceeds the threshold value_{max} (>U) or drops below the threshold value_{min} (<U), the output relays de-energize, the yellow LED turns off and the red LED glows (overvoltage), or flashes  (undervoltage) respectively.

If the measured value decreases below the threshold value_{max} minus the fixed hysteresis (5 %) or exceeds the threshold value_{min} plus the fixed hysteresis (5 %), the tripping delay T_V starts and the red LED turns off.

Timing of T_V is displayed by the flashing  green LED. When T_V is complete, the output relays energize and the yellow LED (relay energized) glows.

If control supply voltage is interrupted, the output relays de-energize and the yellow and green LEDs turn off.

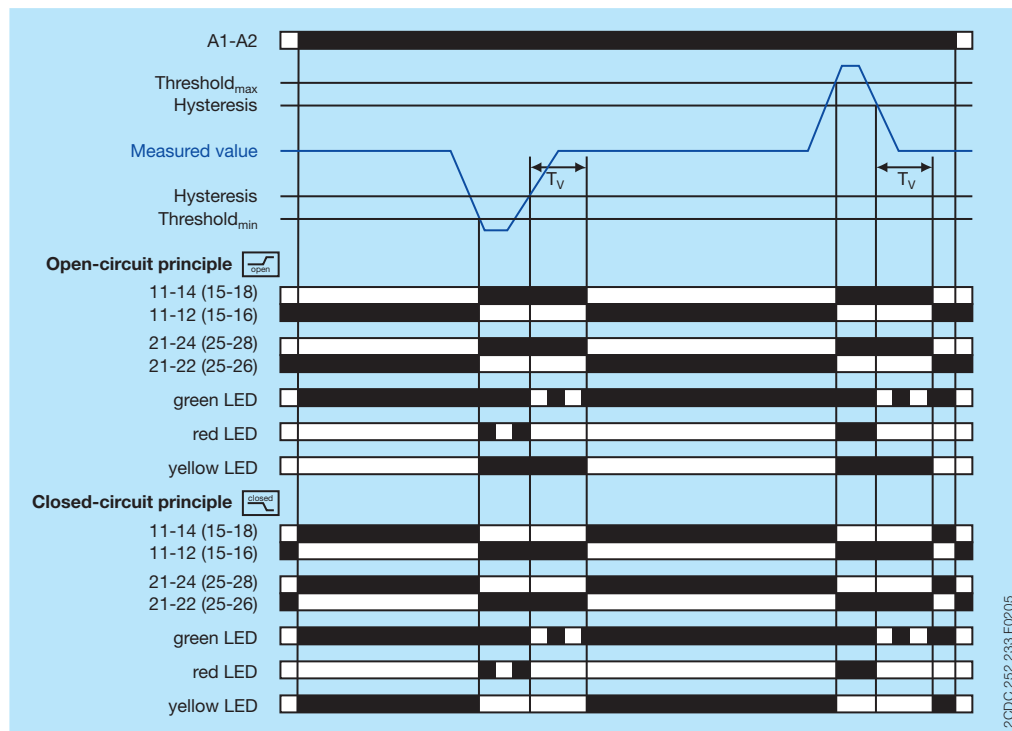

Voltage window monitoring 1x2 c/o (SPDT) contacts ON-delayed with latching

Open-circuit principle

The voltage to be monitored (measured value) is applied to terminals B-C. The control supply voltage applied to terminals A1-A2 is displayed by the glowing green LED.

If the measured value exceeds the threshold value_{max} (>U) or drops below the threshold value_{min} (<U), the tripping delay T_V starts and the red LED glows (overvoltage), or flashes (undervoltage) respectively.

Timing of T_V is displayed by the flashing green LED.

When T_V is complete and the measured value still exceeds the threshold value_{max} minus the fixed hysteresis (5 %) or is still below the threshold value_{min} plus the fixed hysteresis (5 %), the output relays energize and the yellow LED (relay energized) flashes .

If the measured value decreases below the threshold value_{max} minus the fixed hysteresis (5 %) or exceeds the threshold value_{min} plus the fixed hysteresis (5 %), the red LED turns off. The output relays remain energized (latching function).

If control supply voltage is interrupted (reset), the output relays de-energize and the yellow and green LEDs turn off.

Closed-circuit principle

The voltage to be monitored (measured value) is applied to terminals B-C. When control supply voltage is applied to terminals A1-A2, the output relays energize and the green and yellow LED (relays energized) glow.

If the measured value exceeds the threshold value_{max} (>U) or drops below the threshold value_{min} (<U), the tripping delay T_V starts and the red LED glows (overvoltage), or flashes (undervoltage) respectively.

Timing of T_V is displayed by the flashing green LED.

When T_V is complete and the measured value still exceeds the threshold value_{max} minus the fixed hysteresis (5 %) or is still below the threshold value_{min} plus the fixed hysteresis (5 %), the output relays de-energize and the yellow LED (relays energized) flashes .

If the measured value decreases below the threshold value_{max} minus the fixed hysteresis (5 %) or exceeds the threshold value_{min} plus the fixed hysteresis (5 %), the red LED turns off. The output relays remain de-energized (latching function).

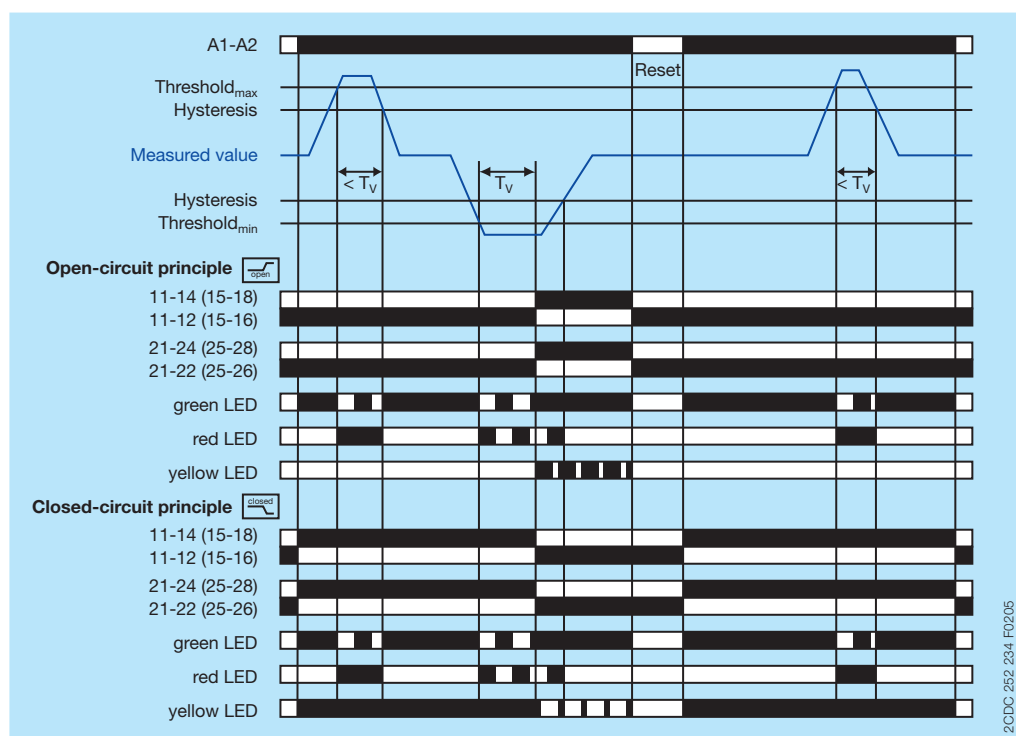

If control supply voltage is interrupted (reset), the yellow and green LEDs turn off. The output relays energize again when control supply voltage is re-applied.



Voltage window monitoring 1x2 c/o (SPDT) contacts OFF-delayed with latching

Open-circuit principle

The voltage to be monitored (measured value) is applied to terminals B-C. The control supply voltage applied to terminals A1-A2 is displayed by the glowing green LED.



If the measured value exceeds the threshold value_{max} (>U) or drops below the threshold value_{min} (<U), the output relays energize, the yellow LED (relays energized) flashes  and the red LED glows (overvoltage), or flashes  (undervoltage) respectively.

If the measured value decreases below the threshold value_{max} minus the fixed hysteresis (5 %) or exceeds the threshold value_{min} plus the fixed hysteresis (5 %), the red LED turns off. The output relays remain energized (latching function).

If control supply voltage is interrupted (reset), the output relays de-energize and the yellow and green LEDs turn off.

Closed-circuit principle

The voltage to be monitored (measured value) is applied to terminals B-C. When control supply voltage is applied to terminals A1-A2, the output relays energize and the green and yellow LED (relays energized) glow.

If the measured value exceeds the threshold value_{max} (>U) or drops below the threshold value_{min} (<U), the output relays de-energize, the yellow LED (relays energized) flashes  and the red LED glows (overvoltage), or flashes  (undervoltage) respectively.

If the measured value decreases below the threshold value_{max} minus the fixed hysteresis (5 %) or exceeds the threshold value_{min} plus the fixed hysteresis (5 %), the red LED turns off. The output relays remain de-energized (latching function).

If control supply voltage is interrupted (reset), the yellow and green LEDs turn off. The output relays energize again when control supply voltage is re-applied.

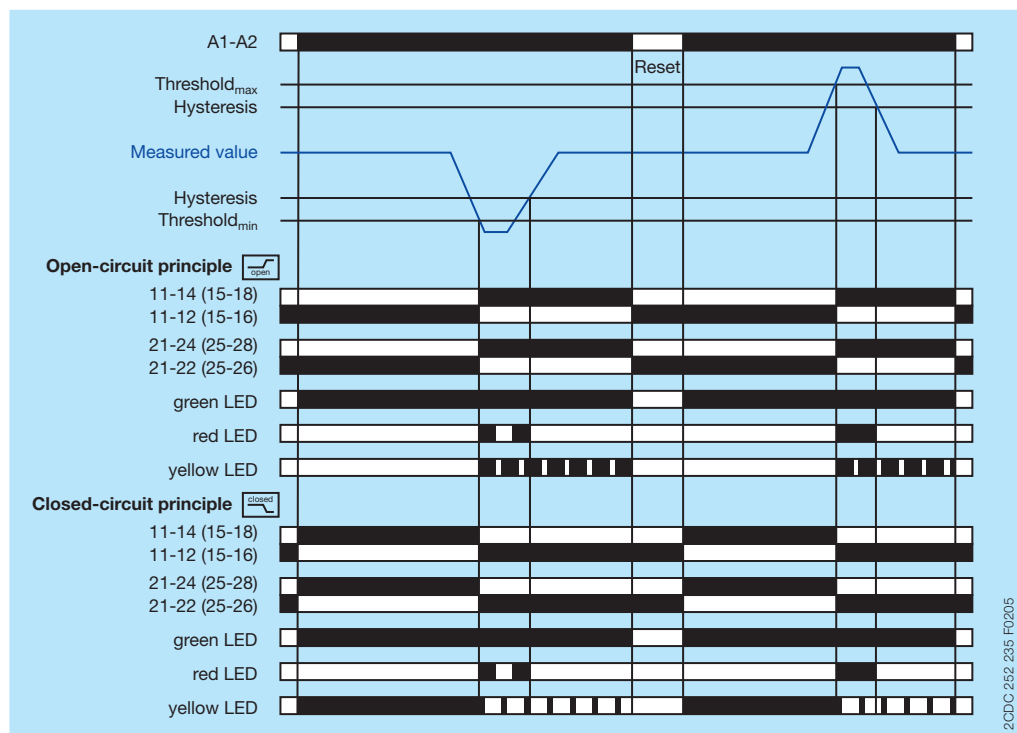

Voltage window monitoring 2x1 c/o (SPDT) contact  ON-delayed  without latching 

Open-circuit principle 

The voltage to be monitored (measured value) is applied to terminals B-C. The control supply voltage applied to terminals A1-A2 is displayed by the glowing green LED.

If the measured value exceeds the threshold value_{max} (>U) or drops below the threshold value_{min} (<U), the tripping delay T_V starts and the red LED glows (overvoltage), or flashes  (undervoltage) respectively.

Timing of T_V is displayed by the flashing  green LED.

When T_V is complete and the measured value still exceeds the threshold value_{max} minus the fixed hysteresis (5 %) or is still below the threshold value_{min} plus the fixed hysteresis (5 %), the output relay 11₁₅-12₁₆/14₁₈ (>U), or 21₂₅-22₂₆/24₂₈ (<U) respectively, energizes and the yellow LED (relay energized) glows.

If the measured value decreases below the threshold value_{max} minus the fixed hysteresis (5 %) or exceeds the threshold value_{min} plus the fixed hysteresis (5 %), the output relay 11₁₅-12₁₆/14₁₈ (>U), or 21₂₅-22₂₆/24₂₈ (<U) respectively, de-energizes and the red and yellow LEDs turn off.

If control supply voltage is interrupted, the green LED turns off.

Closed-circuit principle 

The voltage to be monitored (measured value) is applied to terminals B-C. When control supply voltage is applied to terminals A1-A2, the output relays energize and the green and yellow LED (relays energized) glow.

If the measured value exceeds the threshold value_{max} (>U) or drops below the threshold value_{min} (<U), the tripping delay T_V starts and the red LED glows (overvoltage), or flashes  (undervoltage) respectively.

Timing of T_V is displayed by the flashing  green LED.

When T_V is complete and the measured value still exceeds the threshold value_{max} minus the fixed hysteresis (5 %) or is still below the threshold value_{min} plus the fixed hysteresis (5 %), the output relay 11₁₅-12₁₆/14₁₈ (>U), or 21₂₅-22₂₆/24₂₈ (<U) respectively, de-energizes and the yellow LED (relays energized) turns off.

If the measured value decreases below the threshold value_{max} minus the fixed hysteresis (5 %) or exceeds the threshold value_{min} plus the fixed hysteresis (5 %), the output relay 11₁₅-12₁₆/14₁₈ (>U), or 21₂₅-22₂₆/24₂₈ (<U) respectively, re-energizes, the yellow LED glows and the red LED turns off.

If control supply voltage is interrupted, the output relays de-energize and the yellow and green LEDs turn off.

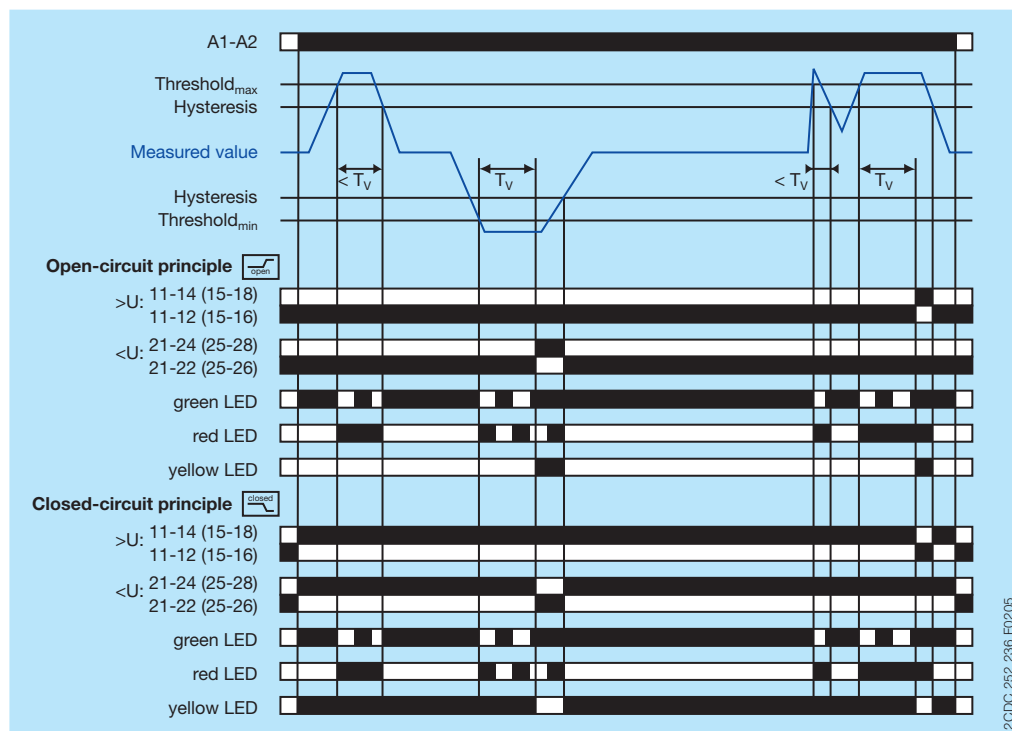

2CDC 252 236 F0205

Voltage window monitoring 2x1 c/o (SPDT) contact  OFF-delayed  without latching 

Open-circuit principle 

The voltage to be monitored (measured value) is applied to terminals B-C. The control supply voltage applied to terminals A1-A2 is displayed by the glowing green LED.

If the measured value exceeds the threshold value_{max} (>U) or drops below the threshold value_{min} (<U), the output relay 11₁₅-12₁₆/14₁₈ (>U), or 21₂₅-22₂₆/24₂₈ (<U) respectively, energizes, the yellow LED (relays energized) glows and the red LED glows (overvoltage), or flashes  (undervoltage) respectively.

If the measured value decreases below the threshold value_{max} minus the fixed hysteresis (5 %) or exceeds the threshold value_{min} plus the fixed hysteresis (5 %), the tripping delay T_v starts and the red LED turns off.

Timing of T_v is displayed by the flashing  green LED. When T_v is complete, the output relay 11₁₅-12₁₆/14₁₈ (>U), or 21₂₅-22₂₆/24₂₈ (<U) respectively, de-energizes and the yellow LED (relay energized) turns off.

If control supply voltage is interrupted, the green LED turns off.

Closed-circuit principle 

The voltage to be monitored (measured value) is applied to terminals B-C. When control supply voltage is applied to terminals A1-A2, the output relays energize and the green and yellow LED (relays energized) glow.

If the measured value exceeds the threshold value_{max} (>U) or drops below the threshold value_{min} (<U), the output relay 11₁₅-12₁₆/14₁₈ (>U), or 21₂₅-22₂₆/24₂₈ (<U) respectively, de-energizes, the yellow LED turns off and the red LED glows (overvoltage), or flashes  (undervoltage) respectively.

If the measured value decreases below the threshold value_{max} minus the fixed hysteresis (5 %) or exceeds the threshold value_{min} plus the fixed hysteresis (5 %), the tripping delay T_v starts and the red LED turns off.

Timing of T_v is displayed by the flashing  green LED. When T_v is complete, the output relay 11₁₅-12₁₆/14₁₈ (>U), or 21₂₅-22₂₆/24₂₈ (<U) respectively, energizes and the yellow LED (relay energized) glows.

If control supply voltage is interrupted, the output relays de-energize and the yellow and green LEDs turn off.

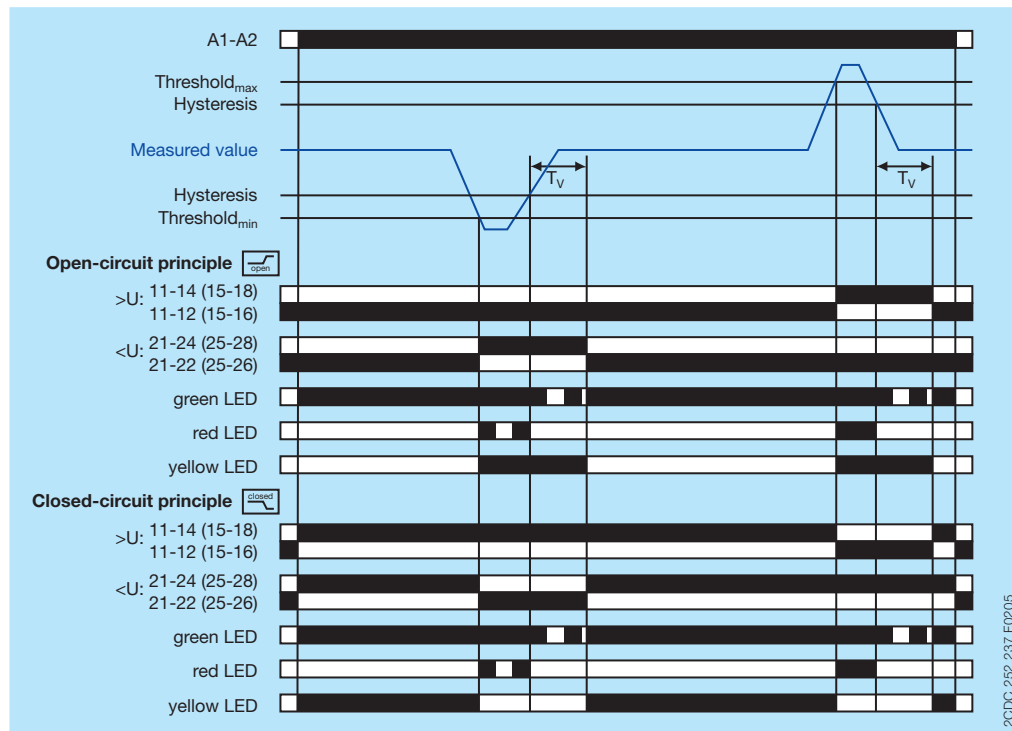

2CDC 252 237 F0205

Voltage window monitoring 2x1 c/o (SPDT) contact  ON-delayed  with latching 

Open-circuit principle 

The voltage to be monitored (measured value) is applied to terminals B-C. The control supply voltage applied to terminals A1-A2 is displayed by the glowing green LED.

If the measured value exceeds the threshold value_{max} (>U) or drops below the threshold value_{min} (<U), the tripping delay T_V starts and the red LED glows (overvoltage), or flashes  (undervoltage) respectively.

Timing of T_V is displayed by the flashing  green LED.

When T_V is complete and the measured value still exceeds the threshold value_{max} minus the fixed hysteresis (5 %) or is still below the threshold value_{min} plus the fixed hysteresis (5 %), the output relay 11₁₅-12₁₆/14₁₈ (>U), or 21₂₅-22₂₆/24₂₈ (<U) respectively, energizes and the yellow LED (relay energized) flashes .

If the measured value decreases below the threshold value_{max} minus the fixed hysteresis (5 %) or exceeds the threshold value_{min} plus the fixed hysteresis (5 %), the red LED turns off. The output relay 11₁₅-12₁₆/14₁₈ (>U), or 21₂₅-22₂₆/24₂₈ (<U) respectively, remains energized (latching function).

If control supply voltage is interrupted (reset), the output relay 11₁₅-12₁₆/14₁₈ (>U), or 21₂₅-22₂₆/24₂₈ (<U) respectively, de-energizes and the yellow and green LEDs turn off.

Closed-circuit principle 

The voltage to be monitored (measured value) is applied to terminals B-C. When control supply voltage is applied to terminals A1-A2, the output relays energize and the green and yellow LED (relays energized) glow.

If the measured value exceeds the threshold value_{max} (>U) or drops below the threshold value_{min} (<U), the tripping delay T_V starts and the red LED glows (overvoltage), or flashes  (undervoltage) respectively.

Timing of T_V is displayed by the flashing  green LED.

When T_V is complete and the measured value still exceeds the threshold value_{max} minus the fixed hysteresis (5 %) or is still below the threshold value_{min} plus the fixed hysteresis (5 %), the output relay 11₁₅-12₁₆/14₁₈ (>U), or 21₂₅-22₂₆/24₂₈ (<U) respectively, de-energizes and the yellow LED (relays energized) flashes .

If the measured value decreases below the threshold value_{max} minus the fixed hysteresis (5 %) or exceeds the threshold value_{min} plus the fixed hysteresis (5 %), the red LED turns off. The output relay 11₁₅-12₁₆/14₁₈ (>U), or 21₂₅-22₂₆/24₂₈ (<U) respectively, remains de-energized (latching function).

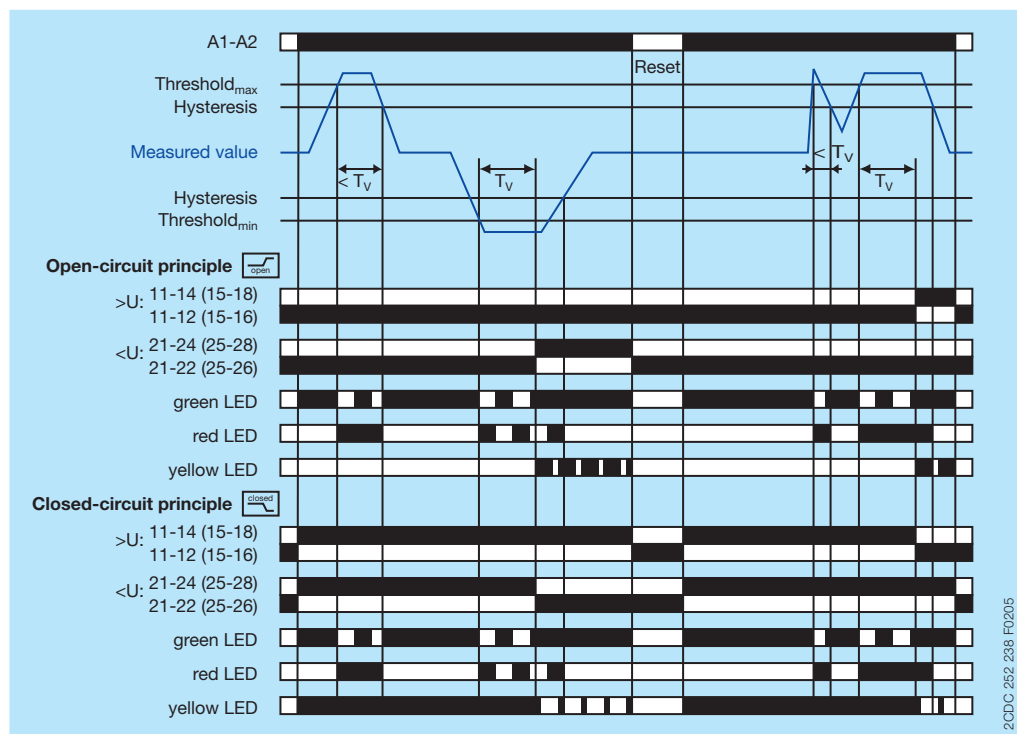

If control supply voltage is interrupted (reset), the yellow and green LEDs turn off. The output relays energize again when control supply voltage is re-applied.



Voltage window monitoring 2x1 c/o (SPDT) contact OFF-delayed with latching

Open-circuit principle

The voltage to be monitored (measured value) is applied to terminals B-C. The control supply voltage applied to terminals A1-A2 is displayed by the glowing green LED.



If the measured value exceeds the threshold value_{max} (>U) or drops below the threshold value_{min} (<U), the output relay 11₁₅-12₁₆/14₁₈ (>U), or 21₂₅-22₂₆/24₂₈ (<U) respectively, energizes, the yellow LED (relays energized) flashes  and the red LED glows (overvoltage), or flashes  (undervoltage) respectively.

If the measured value decreases below the threshold value_{max} minus the fixed hysteresis (5 %) or exceeds the threshold value_{min} plus the fixed hysteresis (5 %), the red LED turns off. The output relay 11₁₅-12₁₆/14₁₈ (>U), or 21₂₅-22₂₆/24₂₈ (<U) respectively, remains energized (latching function).

If control supply voltage is interrupted (reset), the output relays de-energize and the yellow and green LEDs turn off.

Closed-circuit principle

The voltage to be monitored (measured value) is applied to terminals B-C. When control supply voltage is applied to terminals A1-A2, the output relays energize and the green and yellow LED (relays energized) glow.

If the measured value exceeds the threshold value_{max} (>U) or drops below the threshold value_{min} (<U), the output relay 11₁₅-12₁₆/14₁₈ (>U), or 21₂₅-22₂₆/24₂₈ (<U) respectively, de-energizes, the yellow LED (relays energized) flashes  and the red LED glows (overvoltage), or flashes  (undervoltage) respectively.

If the measured value decreases below the threshold value_{max} minus the fixed hysteresis (5 %) or exceeds the threshold value_{min} plus the fixed hysteresis (5 %), the red LED turns off. The output relay 11₁₅-12₁₆/14₁₈ (>U), or 21₂₅-22₂₆/24₂₈ (<U) respectively, remains de-energized (latching function).

If control supply voltage is interrupted (reset), the yellow and green LEDs turn off. The output relays energize again when control supply voltage is re-applied.

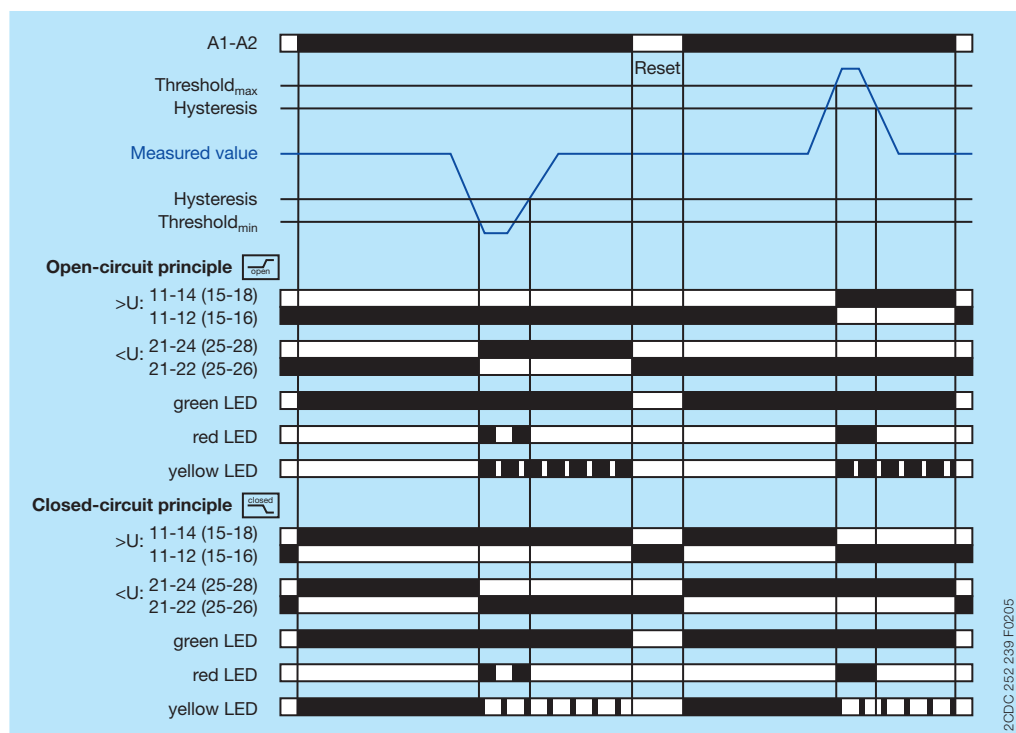

Electrical connection

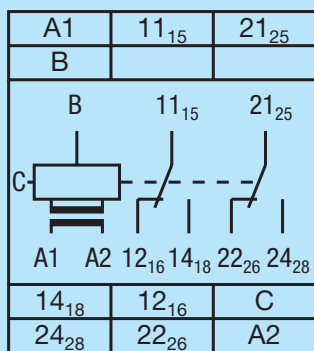

2CDC 252 207 F0005

- A1-A2 Rated control supply voltage
- B-C Measuring ranges: 3-30 V, 6-60 V, 30-300 V, 60-600 V
- 11₁₅-12₁₆/14₁₈ Output contacts - open- or closed-circuit principle
- 21₂₅-22₂₆/24₂₈

Connection diagram

DIP switches

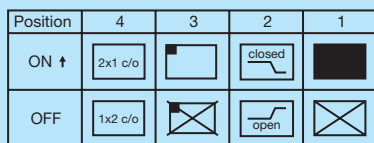

2CDC 252 274 F0005

- 1 ON OFF-delay
 - OFF ON-delay
 - 2 ON Closed-circuit principle
 - OFF Open-circuit principle
 - 3 ON Latching function activated
 - OFF Latching function not activated
 - 4 ON 2x1 c/o (SPDT) contact
 - OFF 1x2 c/o (SPDT) contacts
- OFF = Default

Technical data

Data at $T_a = 25\text{ °C}$ and rated values, unless otherwise indicated







Input circuits

Supply circuit	A1-A2
Rated control supply voltage U_s	24-240 V AC
Rated control supply voltage U_s tolerance	-15...+10 %
Rated frequency	50/60 Hz
Typical current / power consumption	24 V DC 30 mA / 0.75 W 115 V AC 17 mA / 1.9 VA 230 V AC 11 mA / 2.6 VA
Power failure buffering time	20 ms
Transient overvoltage protection	varistors

Measuring circuit	B-C
Monitoring function	Over- and undervoltage monitoring
Measuring method	TRMS measuring principle
Measuring inputs	terminal connection B-C measuring range 3-30 V, 6-60 V, 30-300 V, 60-600 V input resistance 600 k Ω pulse overload capacity $t < 1\text{ s}$ 800 V continuous capacity 660 V
Threshold value	>U and <U adjustable within the indicated measuring range
Tolerance of the adjusted threshold value	10 % of the range end value
Hysteresis related to the threshold value	5 % fixed
Measuring signal frequency range	DC / 15 Hz - 2 kHz
Rated measuring signal frequency range	DC / 50-60 Hz
Maximum response time	AC 80 ms DC 120 ms
Accuracy within the rated control supply voltage tolerance	$\Delta U \leq 0.5\%$
Accuracy within the temperature range	$\Delta U \leq 0.06\% / \text{°C}$
Transient overvoltage protection	varistors

Timing circuit	
Time delay T_V	0 s or 0.1-30 s adjustable
Repeat accuracy (constant parameters)	$\pm 0.07\%$ of full scale
Tolerance of the adjusted time delay	-
Accuracy within the rated control supply voltage tolerance	$\Delta t \leq 0.5\%$
Accuracy within temperature range	$\Delta t \leq 0.06\% / \text{°C}$

User interface

Indication of operational states		
Control supply voltage	U/T: green LED	 : control supply voltage applied  : tripping delay T_V active
Measured value	U: red LED	 : overvoltage  : undervoltage
Relay status	R: yellow LED	 : output relay energized, no latching function  : output relay energized, active latching function  : output relay de-energized, active latching function

Output circuits

Kind of output	11-12/14	relay, 1st c/o (SPDT) contact
	21-22/24	relay, 2nd c/o (SPDT) contact 1 x 2 c/o (SPDT) contacts (common signal) or 2 x 1 c/o (SPDT) contact (separate signal for >U and <U) configurable
Operating principle	open- or closed-circuit principle configurable (open-circuit principle: output relays energize if the measured value exceeds \square / falls below \square the adjusted threshold value, closed-circuit principle: output relays de-energize if measured value exceeds \square / falls below \square the adjusted threshold value)	
Contact material	AgNi	
Rated operational voltage U_o (VDE 0110, IEC/EN 60947-1)	250 V	
Minimum switching voltage / Minimum switching current	24 V / 10 mA	
Maximum switching voltage / Maximum switching current	250 V AC / 4 A AC	
Rated operational current I_e (IEC/EN 60947-5-1)	AC12 (resistive) at 230 V	4 A
	AC15 (inductive) at 230 V	3 A
	DC12 (resistive) at 24 V	4 A
	DC13 (inductive) at 24 V	2 A
AC rating (UL 508)	utilization category (Control Circuit Rating Code)	B 300
	max. rated operational voltage	300 V AC
	max. continuous thermal current at B 300	5 A
	max. making/breaking apparent power at B 300	3600/360 VA
Mechanical lifetime	30 x 10 ⁶ switching cycles	
Electrical lifetime	AC12, 230 V, 4 A	0.1 x 10 ⁶ switching cycles
Maximum fuse rating to achieve short-circuit protection	n/c contact	6 A fast-acting
	n/o contact	10 A fast-acting

General data

MTBF	on request	
Duty time	100 %	
Dimensions (W x H x D)	product dimensions	22.5 x 85.6 x 103.7 mm (0.89 x 3.37 x 4.08 in)
	packaging dimensions	97 x 109 x 30 mm (3.82 x 4.29 x 1.18 in)
Weight		Screw connection technology
		Easy Connect Technology (Push-in)
	Net weight	0.157 kg (0.346 lb) 0.146 kg (0.322 lb)
	Gross weight	0.179 kg (0.395 lb) 0.168 kg (0.370 lb)
Mounting	DIN rail (IEC/EN 60715), snap-on mounting without any tool	
Mounting position	any	
Material of housing	UL 94 V-0	
Degree of protection	housing	IP50
	terminals	IP20

Electrical connection

		Screw connection technology	Easy Connect Technology (Push-in)
Wire size	fine-strand with(out) wire end ferrule	1 x 0.5-2.5 mm ² (1 x 20-14 AWG) 2 x 0.5-1.5 mm ² (2 x 20-16 AWG)	2 x 0.5-1.5 mm ² (2 x 20-16 AWG)
	rigid	1 x 0.5-4 mm ² (1 x 20-12 AWG) 2 x 0.5-2.5 mm ² (2 x 20-14 AWG)	2 x 0.5-1.5 mm ² (2 x 20-16 AWG)
Stripping length		8 mm (0.32 in)	
Tightening torque		0.6 - 0.8 Nm (5.31 - 7.08 lb.in)	-

Environmental data

Ambient temperature ranges	operation	-20...+60 °C
	storage	-40...+85 °C
Damp heat, cyclic (IEC 60068-2-30)		55 °C, 6 cycle
Vibration, sinusoidal (IEC/EN 60255-21-1)		class 2
Shock (IEC/EN 60255-21-2)		class 2

Isolation data

Rated insulation voltage U _i (VDE 0110, IEC/EN 60947-1, IEC/EN 60255-5)	supply / measuring circuit / output	600 V
	supply / output 1 / output 2	250 V
Rated impulse withstand voltage U _{imp} (IEC/EN 60947-1, IEC/EN 60255-5)	supply / measuring circuit / output	6 kV 1.2/50 μs
	supply / output 1 / output 2	4 kV 1.2/50 μs
Test voltage between all isolated circuits (type test)	rated insulation voltage 250 V	2.0 kV, 50 Hz
	rated insulation voltage 600 V	2.5 kV, 50 Hz
Pollution degree (VDE 0110, IEC/EN 60664, IEC/EN 60255-5)		3
Overvoltage category (VDE 0110, IEC/EN 60664, IEC/EN 60255-5)		III

Standards

Product standard	IEC/EN 60255-6
Low Voltage Directive	2006/95/EC
EMC Directive	2004/108/EC
RoHS Directive	2002/95/EC

Electromagnetic compatibility

Interference immunity to		IEC/EN 61000-6-2
electrostatic discharge	IEC/EN 61000-4-2	Level 3
radiated, radio-frequency, electromagnetic field	IEC/EN 61000-4-3	Level 3
electrical fast transient / burst	IEC/EN 61000-4-4	Level 3
surge	IEC/EN 61000-4-5	Level 3
conducted disturbances, induced by radio-frequency fields	IEC/EN 61000-4-6	Level 3
Interference emission		IEC/EN 61000-6-3
high-frequency radiated	IEC/CISPR 22, EN 55022	Class B
high-frequency conducted	IEC/CISPR 22, EN 55022	Class B

Technical diagrams

Load limit curves

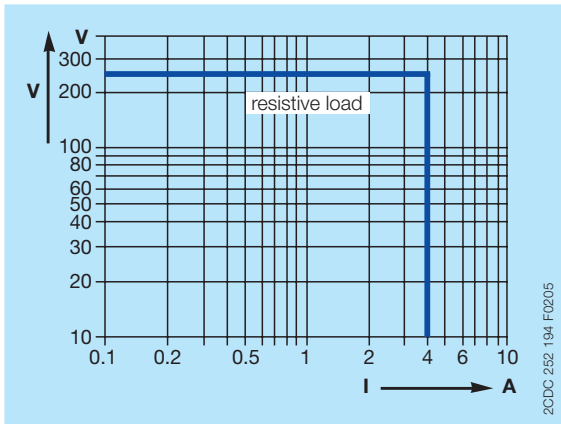

AC load (resistive)

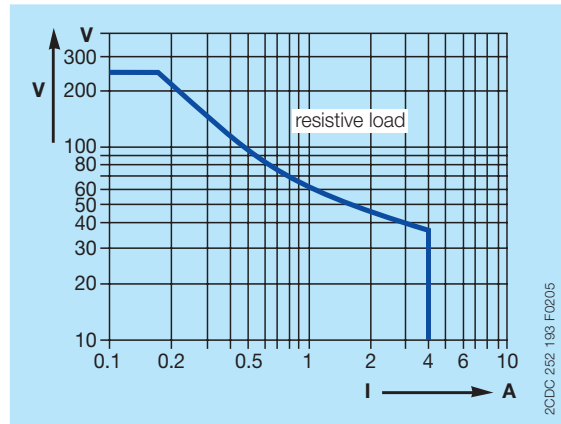

DC load (resistive)

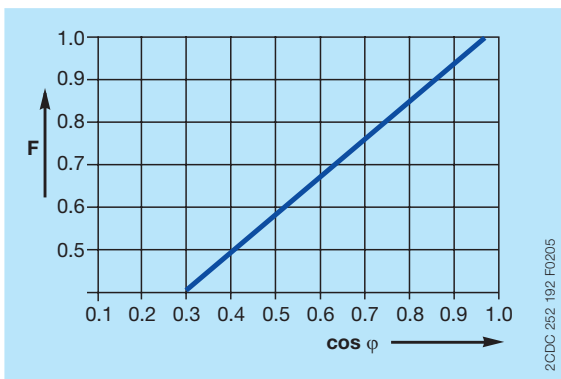

Derating factor F for inductive AC load

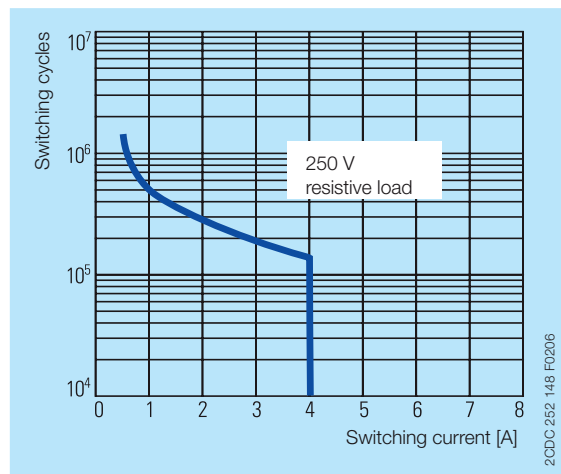

Contact lifetime

Dimensions

in **mm** and *inches*

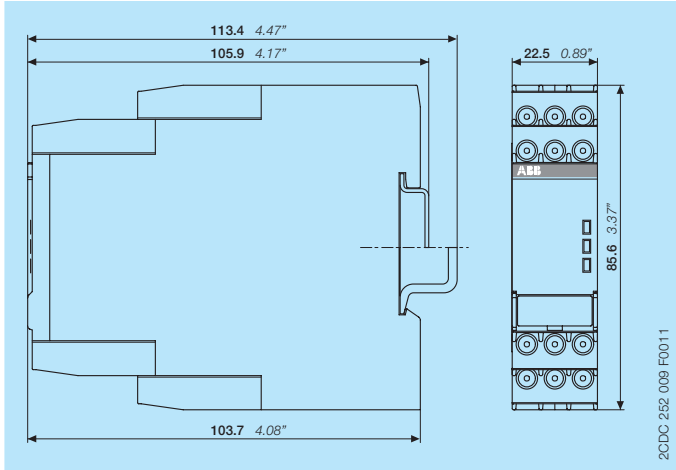

Accessories

in **mm** and *inches*

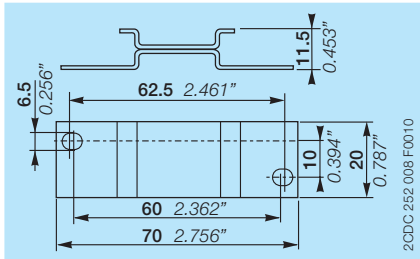

ADP.01 - Adapter for screw mounting

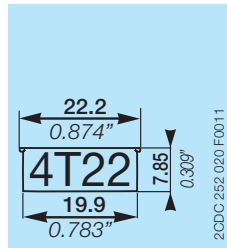

MAR.12 - Marker label for devices with DIP switches

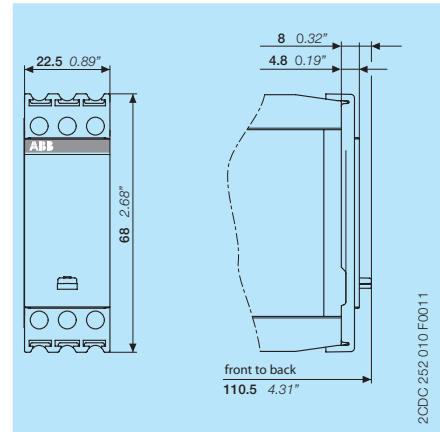

COV.11 - Sealable transparent cover

Further documentation

Document title	Document type	Document number
Electronic products and relays	Technical catalogue	2CDC 110 004 C020x
CM-EFS.2	Instruction manual	1SVC 730 570 M0000

You can find the documentation on the internet at www.abb.com/lowvoltage -> Control Products
-> Electronic Relays and Controls -> Single Phase Monitors

Contact us

ABB STOTZ-KONTAKT GmbH

P. O. Box 10 16 80
69006 Heidelberg, Germany
Phone: +49 (0) 6221 7 01-0
Fax: +49 (0) 6221 7 01-13 25
E-mail: info.desto@de.abb.com

You can find the address of your
local sales organisation on the
ABB home page
<http://www.abb.com/contacts>
-> Low Voltage Products and Systems

Note:

We reserve the right to make technical changes or modify the contents of this document without prior notice. With regard to purchase orders, the agreed particulars shall prevail. ABB AG does not accept any responsibility whatsoever for potential errors or possible lack of information in this document.

We reserve all rights in this document and in the subject matter and illustrations contained therein. Any reproduction, disclosure to third parties or utilization of its contents – in whole or in parts – is forbidden without prior written consent of ABB AG.

Copyright© 2010 ABB
All rights reserved